



EXISTING DRIVEWAY CONDITION
VIEW FROM MUSIC STREET



EXISTING BARN & GUEST HOUSE
VIEW FROM DRIVEWAY



EXISTING BARN & GUEST HOUSE
VIEW FROM DRIVEWAY

Martha's Vineyard
11 Music Street
West Tisbury, MA 02575
Boston
15 Channel Center Street
#510
Boston, MA 02210
**MUSIC STREET
ARCHITECTS**
Architecture • Design • Master Planning
508.274.2905
josh@musicstreetco.com
musicstreetco.com

GOTHARD RESIDENCE
11 MUSIC STREET, WEST TISBURY, MA

HDC REVIEW

APRIL 26, 2022

MUSIC STREET

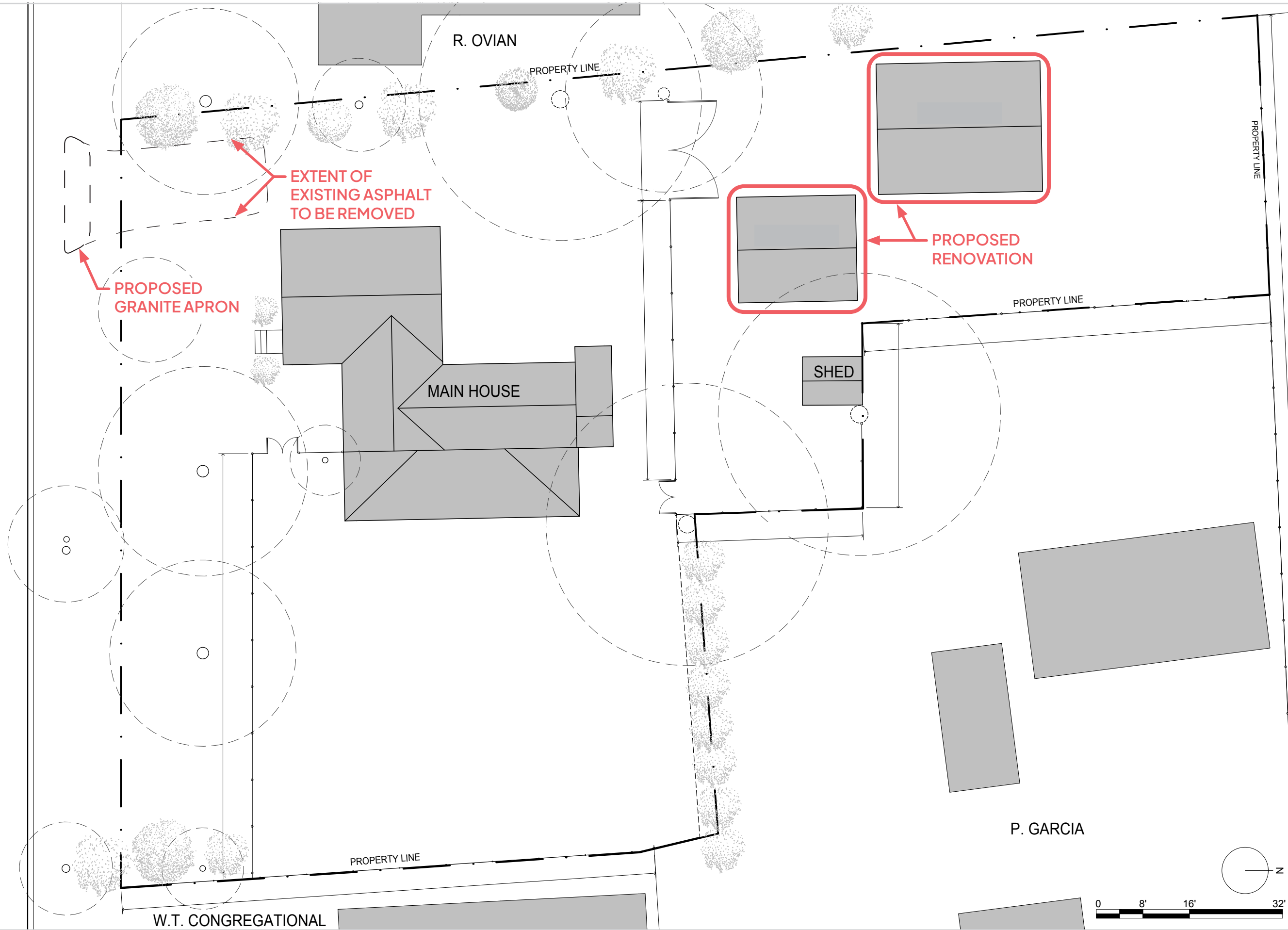

Martha's Vineyard
 11 Music Street
 West Tisbury, MA 02575
Boston
 15 Channel Center Street
 #510
 Boston, MA 02210

MUSIC STREET ARCHITECTS
 Architecture - Design - Master Planning
 508.274.2905
 josh@musicstreetco.com
 musicstreetco.com

GOTHARD RESIDENCE
 11 MUSIC STREET, WEST TISBURY, MA

SITEPLAN

2

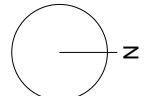

HDC REVIEW

APRIL 26, 2022



① OVERALL - EXISTING SOUTH
1/4" = 1'-0"

EXISTING ELEVATION

3

GOTHARD RESIDENCE
11 MUSIC STREET, WEST TISBURY, MA

**MUSIC STREET
ARCHITECTS**
Architecture - Design - Master Planning
508.274.2905
josh@musicstreetco.com
musicstreetco.com

Martha's Vineyard
11 Music Street
West Tisbury, MA 02575
Boston
15 Channel Center Street
#510
Boston, MA 02210

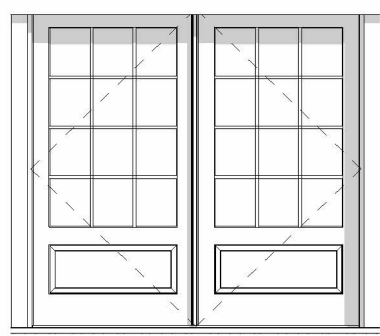

5. INNER DOOR 200
1/4" = 1'-0"

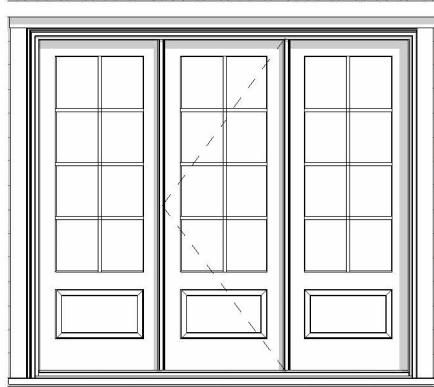

6. INNER DOOR 100
1/4" = 1'-0"

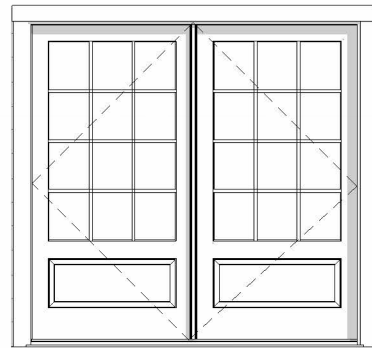

7. INNER DOOR 101
1/4" = 1'-0"

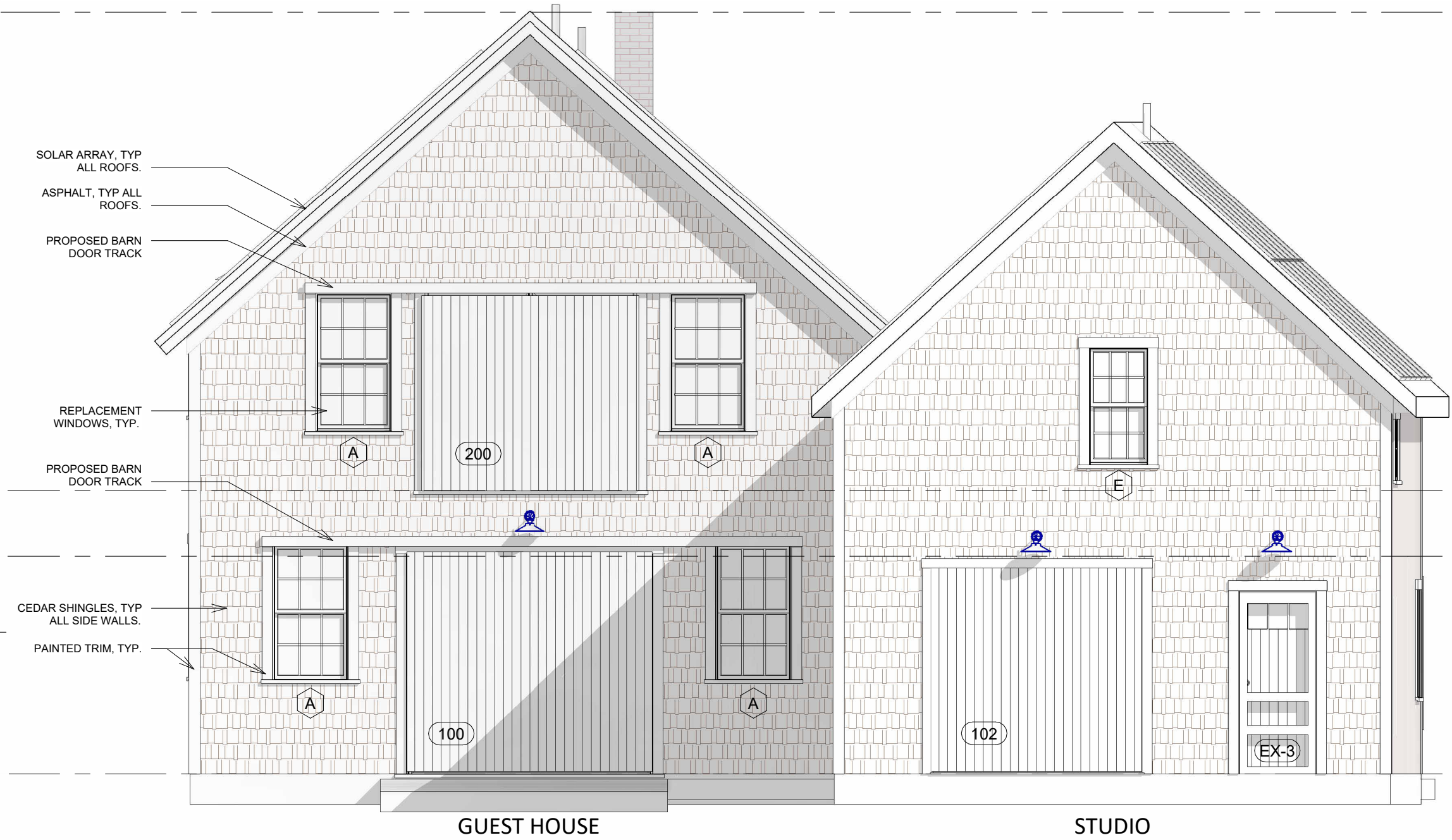

1. OVERALL - PROPOSED SOUTH
1/4" = 1'-0"

Martha's Vineyard
11 Music Street
West Tisbury, MA 02575
Boston
15 Channel Center Street
#510
Boston, MA 02210

MUSIC STREET ARCHITECTS
Architecture - Design - Master Planning
508.274.2905
josh@musicstreetco.com
musicstreetco.com

GOTHARD RESIDENCE
11 MUSIC STREET, WEST TISBURY, MA

PROPOSED ELEVATION

4

APRIL 26, 2022

HDC REVIEW



Solar Array



Weathered Wood

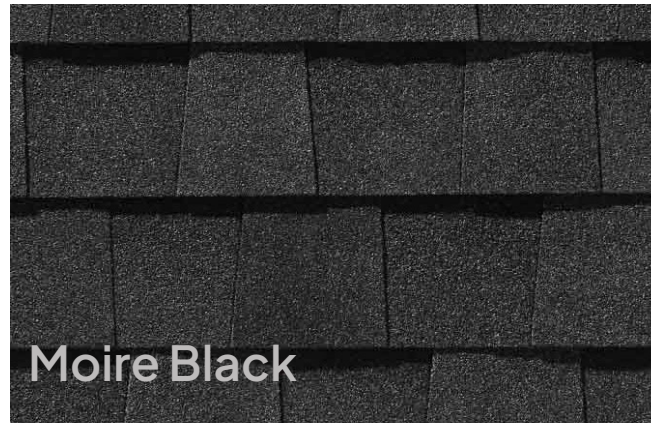

Moire Black

Proposed Roofing Material



Existing Exterior Trim Details to be Replicated



Driveway Material - Granite Apron & Pea Stone



Existing Exterior Siding Materials to be Replicated

Martha's Vineyard
11 Music Street
West Tisbury, MA 02575
Boston
15 Channel Center Street
#510
Boston, MA 02210
MUSIC STREET
ARCHITECTS
Architecture - Design - Master Planning
508.274.2905
josh@musicstreetco.com
musicstreetco.com

GOTHARD RESIDENCE
11 MUSIC STREET, WEST TISBURY, MA

MATERIALS

5

Dominion Gooseneck Light

Light Source: Incandescent/GU24

Shade Size: 16" Shade

Shade Finish: 200-White

Gooseneck Arm Finish: Same as Shade

Shade Accessory: None

Mounting Accessory: None

Socket Type: E26

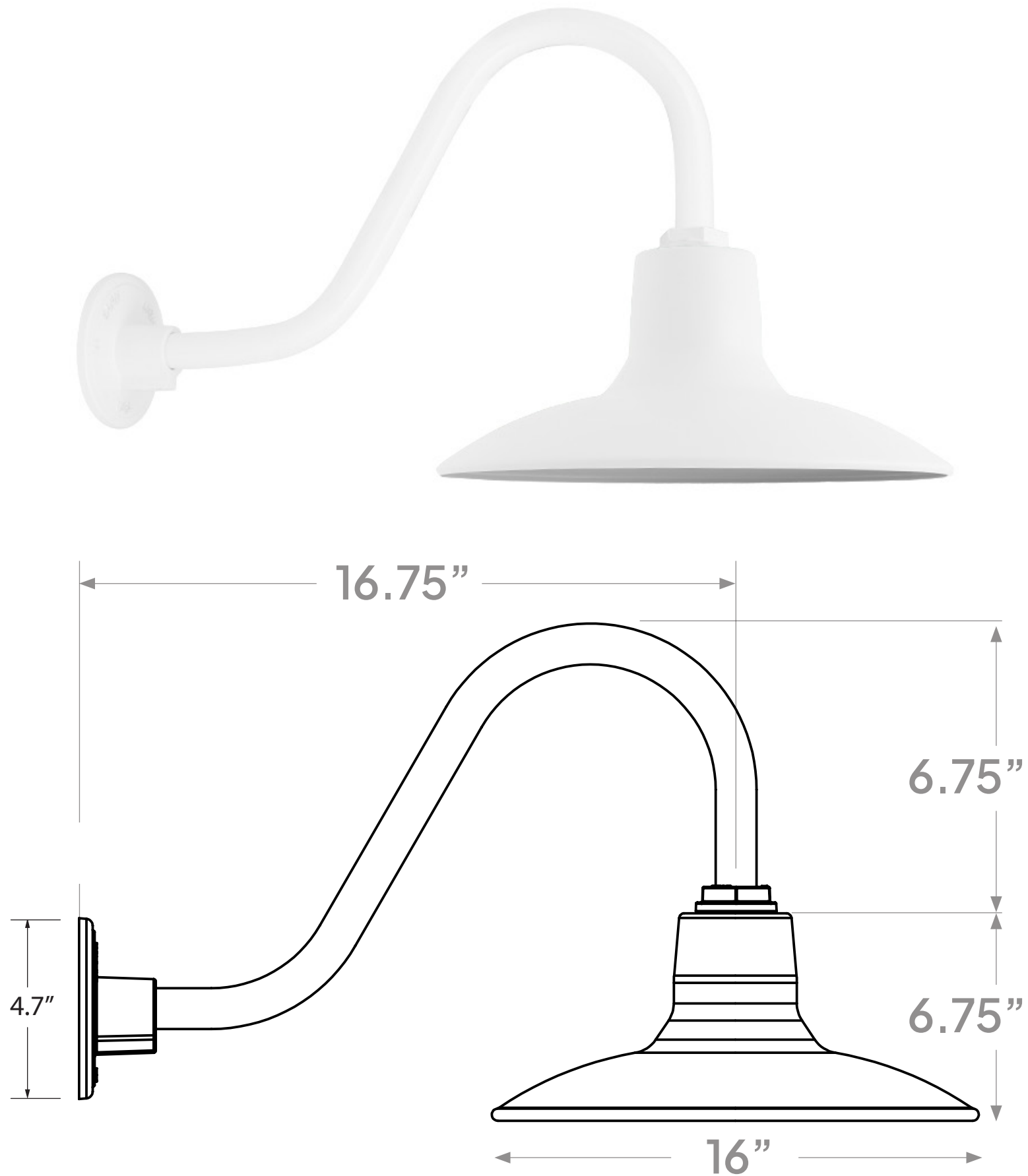

Martha's Vineyard
11 Music Street
West Tisbury, MA 02575

MUSIC STREET ARCHITECTS
Architecture - Design - Master Planning
508.274.2905
josh@musicstreetco.com
musicstreetco.com

GOTHARD RESIDENCE
11 MUSIC STREET, WEST TISBURY, MA

FIXTURES

6

HDC REVIEW

APRIL 26, 2022



Paired with SDL bars on the exterior of the glass, a spacer bar is installed between the glass, creating an even closer match to the Authentic Divided Lite look.

Simulated Divided Lite with Spacer Bar



Double Hung Windows

Martha's Vineyard
11 Music Street
West Tisbury, MA 02575

MUSIC STREET ARCHITECTS
Architecture • Design • Master Planning
508.274.2905
josh@musicstreetco.com
musicstreetco.com

GOTHARD RESIDENCE
11 MUSIC STREET, WEST TISBURY, MA

WINDOW TYPE

7